

### **LITILE - A revolutionary invention of seamless display wall which can make the screen size unlimited...**

#### **The sunlight readable and high resolution video wall**

To offer the total solution in the digital signage industry, LITEMAX has launched the world-leading seamless panel wall - LITILE from the beginning of 2008. According to LITILE's four "S" features - Slim, Seamless, Scalable and Sunlight Readable, you can build an unlimited size panel wall. Due to taking Sunlight Readable LCD panel, LITILE can be viewed clear under daylight. The high brightness display wall will be your new marketing tool to catch your target audience easier!

#### **Main Features - 4 "S"**

- **S**unlight Readable  
High luminance ( $>1000 \text{ cd/m}^2$ ) and high resolution (1.7mmx1.7mm with 90% fill factor)
- **S**eamless - Seamless tiling capability
- **S**calable - Modular flexibility
- **S**lim

#### **Applications:**

- Retail store
- Concert
- Hotel & Casino
- Exhibition
- TV Studio
- Control Room
- Shopping Mall
- Public Information
- Cinema
- Airport/ Station

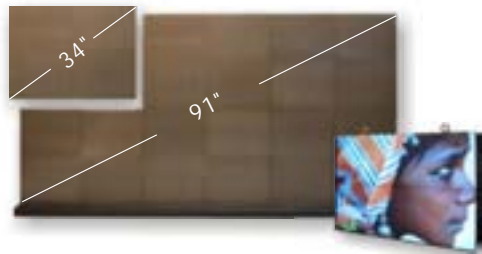

Cai Guo-Qiang, Illusion II (2006)

8 minutes and 48 seconds, loop

Two-channel video installation  
Videography by John Brost; Edited by Lauren Petty

Installation view at TFAM, 2009

Photo by ON OFFICE





### **LITILE Module**

- 34" Sunlight Readable LCD Panel Display
- Seamless, Frameless
- Scalable, Multiple Creative Display Styles
- Slim Mechanical Design



### **MDU (Modular Display Unit) Controller**

- Each MDU can drive up to 6 LITILE modules for a set



### **Scaler Unit**

- Support different video inputs like VGA, DVI and Composite etc.
- Work with MDU to output video with different resolutions.



### **LITILE Flying Case**

- Flight Case Base Plate
- "2 Modules In 1" Design

## COMPARISON OF LARGE AREA DISPLAY TECHNOLOGIES

	 Litile	LCD	Plasma	Rear Projection Cubes	LED 6mm	LED 3mm
<b>Typical PixelPitch</b>	1.7mm	0.75mm	1.05mm	1.3mm	6mm	3mm
<b>Full Colour</b>	✓✓	✓✓	✓✓	✓✓	✓	✓
<b>Video and Text</b>	✓	✓	✓	✓	✓	✓
<b>Low Profile</b>	✓	✓✓	✓✓		✓	✓
<b>Sunlight Readable</b>	✓✓	✓			✓✓	✓
<b>Usable for Displays &gt;106" Diagonal</b>	✓			✓	✓	
<b>High Resolution</b>	✓	✓	✓	✓		
<b>Usable From Close Range (&lt;5m)</b>	✓	✓	✓	✓		
<b>Flexible Format</b>	✓			✓	✓	✓
<b>Mullions (mm)</b>	None	Wide	Wide-Medium	Narrow	None	None

✓ = Suitable; ✓✓ = Highly Suitable



Litile



LCD



Plasma



LED

## SCREEN SHAPES AND SIZE

LITILE modules can be arranged into a variety of different screen shapes. The chart below shows the screen diagonal, the associated wall size and the display resolution. LITILE not only allows a breakthrough from the conventional 4:3 and 16:9 aspect ratios, but also more rectangular formats altogether!

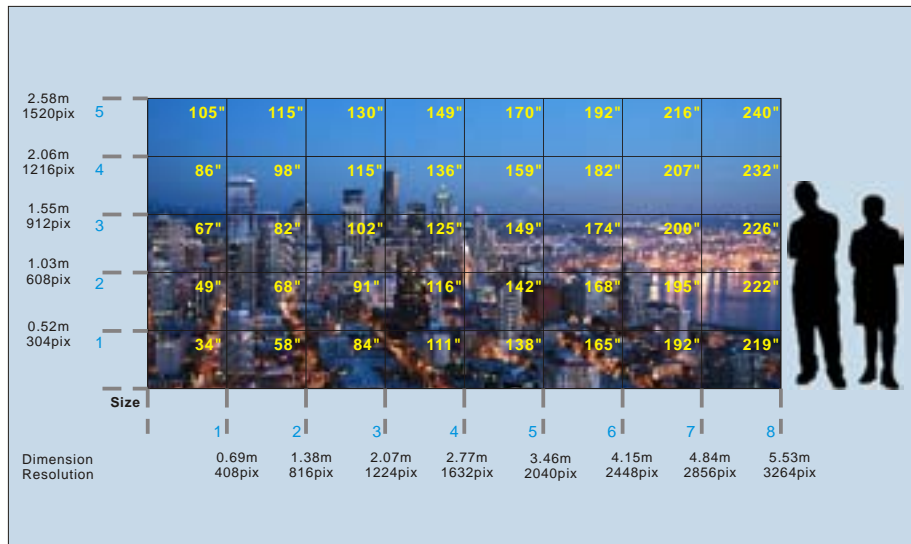

## USER-FRIENDLY MECHANICAL DESIGN

In order to provide the total solution of display wall installation, LITEMAX R&D team concentrated on the innovation of the mechanical design by many tests and a long-term research. LITEMAX believes that these specifics below will be useful to setup the robust display wall smoothly and safer.



The flow of LITILE video wall installation can refer to the chart below. After setting the video source from a digital signage server or a media player, the video scaler can do an adjustment to deliver the suitable video or picture to the MDU controller. By the distribution of the MDU controller, the video content will be split and delivered up to six LITILE modules. Stacking the LITILE modules with creativity, your only one LITILE display wall will work and show the most attractive message to your audience.

The size and position of the video can be adjusted by the Video Scaler. Then the video clip will be delivered to many LITILE modules. A MDU controller can drive upon 6 LITILE modules

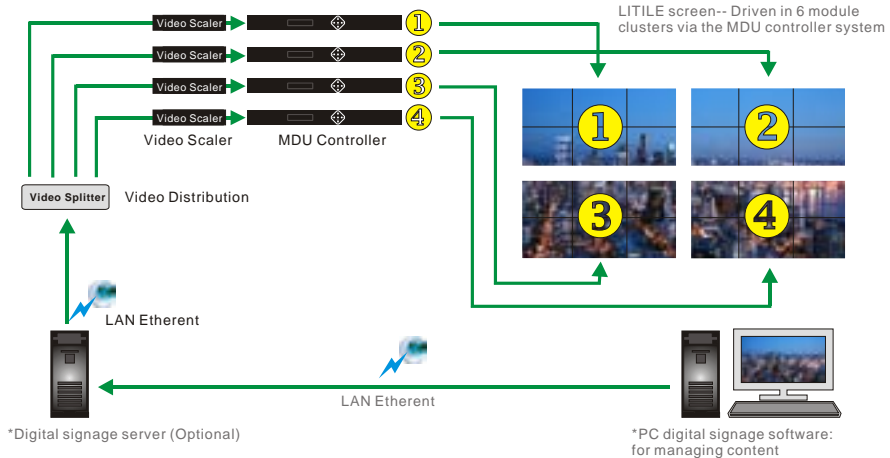

**LITILE is the only video wall solution with the following unique features and benefits:**



**High luminance (>1000cd/m<sup>2</sup>) and high resolution (1.7mm)**

- Near (or far) distance watching the display wall in a bright location
- Superior image quality - LITILE can show more attractive digital content and replace traditional poster or LED wall.
- 1080p High-Definition video support at over 180" video wall



**Modular flexibility**

The new revenue tool. An exciting and eye-catching unusual shaped screen can allow media agency to entice their clients to create a new business in the competitive advertising industry.



**Seamless tiling capability**

No visible mullions to break up the image or message



**No red, green & blue pixel separation and high pixel fill factor (92%)**

Lack of pixelation means no Moire interference with TV cameras offering high quality backdrops for TV shows and filmed events



**Full colour video and text support**

Keep viewers engaged through the combination of information, advertising and entertainment on the same wall.

## LITILE MODULE DIMENSION

Unit: mm

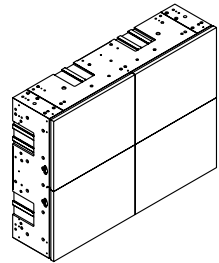
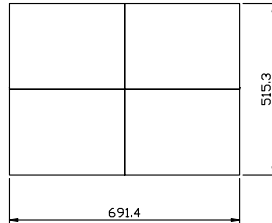
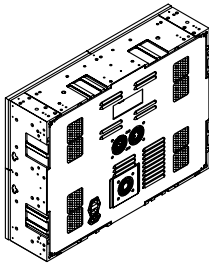

LITILE modules can be stacked and composed unlimited for different event venues and projects.

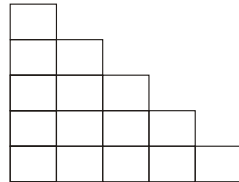
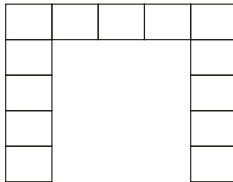
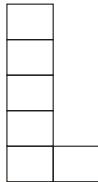
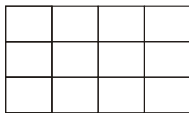

## LITILE MODULE SPECIFICATION

Model Number	LITILE
<b>Physical</b>	
<b>Dimensions</b>	691.4x515.3x180mm
<b>Diagonal</b>	34" nominal (862.4mm)
<b>Weight</b>	38kg
<b>Mounting</b>	Free standing or frame mounting
<b>Maintenance</b>	On-site 5-min swap time
<b>Optical</b>	
<b>Resolution (Fibre Optical)</b>	408x304
<b>Pixel Size</b>	1.7mmx1.7mm with 90% fill factor
<b>Number of Colors</b>	16.7 million
<b>Response Time</b>	8ms
<b>Brightness</b>	up to 1200 cd/m <sup>2</sup>
<b>Dimming Range</b>	10:1 (electronic /manual)
<b>Contrast Ratio</b>	180:1 in dark room (>10:1 with 10,000 lux ambient)
<b>Viewing Angle H&amp;V</b>	160°( dark room with CR>10:1)
<b>Electrical /inputs</b>	
<b>Video Source Video Splitter</b>	DVI, VGA or Composite
<b>Power Supply</b>	Single Phase, 110-240 V AC
<b>Power Consumption</b>	250 W
<b>Environmental</b>	
<b>Operating Temperature Range</b>	0°C to 50°C
<b>Storage Temperature Range</b>	-20C to 60C
<b>Operating Humidity Range</b>	20% to 85%, Non Condensing
<b>Storage Humidity Range</b>	5% to 95%, Non Condensing

*Specifications are subject to change without notice.*

*All brands or productnames are trademarks or registered trademarks of their respective companies.*

**How does LITILE compare with LED wall?**

There are many reasons to choose LITILE for your new choice from common video wall solutions. Comparing with LED wall, three mainly reasons of the chosen LITILE module are "High resolution", "stable from close rang (<1m)" and "Lower power consumption". For the detail of LITILE features, please contact with LITEMAX sales.

**Can it be waterproof?**

LITILE itself does not support waterproofing. However, after assembling with a specific protector, this solution can be operated sufficiently outdoor.

**How do you secure the structure safety?**

By the unique user-friendly mechanical design, especially the "hanging ring" and the "easy-alignment lock" design can make sure the structure secure and stable.

**How do I assemble a 4x2(m) panel wall?**

To assemble a huge LITILE video wall should take some points for a better installation experience. First of all, an exactly flat platform should be set up. By the user-friendly mechanical design, you can move and install each tile module easily. After installing the first row of modules exactly, the other rows will be composed accurately by the first row. During the whole installation, hanging rings can be used for a safer process of module installation.

**Why is only 34" per module?**

Due to the research and technology development, 34-inch tile module is the suggested size for free stacking installation nowadays. LITEMAX is going to keep the vision of innovation to supply the newest video solution in future.

**How much space should I need to reserve for the rear side?**

By means of modules installation and heat dissipation, reserving one meter space is suggested for a better operation environment.

**Is it easy to maintain the LITILE module?**

Yes. The time of swapping each LITILE module is under 5 minutes.

**What is the life of the display?**

By the conscientious test of LITILE, the life of each module is over 50,000 hours.

---

**JAYCO**mmi  
[www.ultra-displays.com](http://www.ultra-displays.com)

*Clarity You Can Depend On*

For immediate service call 1 (951) 738-2000



**LiTILE** Seamless Display Wall